

PRODUCT

C A T A L O G



FLAGS • BEACHFLAGS • BANNERS • DISPLAY SYSTEMS • FLATBED



○ FLAGS

Flags are used to express national pride and also advertise service or business effectively. We offer corporate flags, advertising flags, national flags, custom-made flags, hand-sewn flags or coat of arms flags. Flags are mainly printed digitally with dye sub, but screen printing method is also available.

● FINISHING

PLASTIC HOOK



ROPE CLIP



FLAT CLIP (RED / WHITE)



METAL EYELET



D-RING



ROPE LOOP



TUNNEL / SLEEVE



HEADBAND LOOP

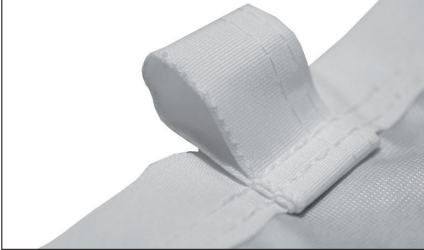

ROPE AND TOGGLE



● DIGITAL PRINTING

- Polyglans 115 g/m²
- Polyglans 115 g/m² B1
- Air Polyglans 115 g/m²



BEACHFLAGS

- S - small | 250 cm
- M - medium | 300 cm
- L - large | 390 cm
- XL - extra large | 455 cm

One of our top sellers. The original and unique shapes draw everyone's attention. The customer is offered a wide range of sizes, shapes and bases. The broad selection of bases allows using beachflags on various surfaces such as sand, snow, ice, concrete or grass. The system is light-weight, durable and quick and easy to assemble.

SHAPES

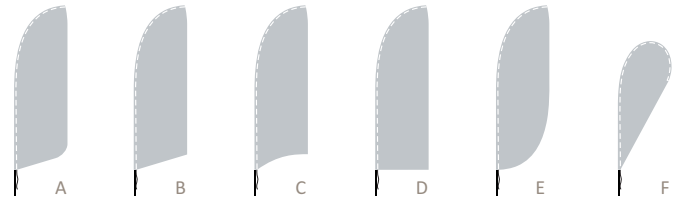

BASES

SCREW



CROSSBASE WITH WATERBAG



PLASTIC FILLABLE BASE
(FOR WATER OR SAND)



HEAVY FLAT METAL BASE

6 kg
15 kg
20 kg



HEAVY ECO BASE

5 kg
12 kg



SPIKE



DRIVE-ON BASE
ECO
BUSINESS

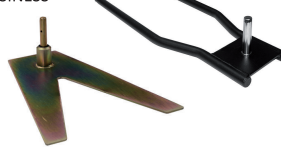

2,5 KG METAL BASE
(only for beachflag S)



SET INCLUDES

- flag
- pole
- size S: 2,5 kg light-weight metal base
- sizes M, L, XL: plastic screw rotating base
- carry bag

MATERIALS

- Polyglans 115 g/m²
- Polyglans 115 g/m² B1
- Air Polyglans 115 g/m²



HEAVY DUTY ALUMINIUM BEACHFLAGS

M - medium | 300 cm
L - large | 400 cm

Heavy duty version of standard beachflags. The original and unique shape draws everyone's attention. Beachflags are offered in two sizes and shapes, with a broad selection of bases. 100% aluminium hardware guarantees long-term durability. Aluminium beachflags are ideal for large-scale outdoor campaigns.

SHAPES



NORMAL



DROP

BASES

BLACK CROSSBASE



BLACK WATERBAG



HEAVY FLAT METAL BASE

6 kg
15 kg
20 kg



HEAVY ECO BASE

5 kg
12 kg



PLASTIC FILLABLE BASE
(FOR WATER OR SAND)



BLACK SPIKE



BUSINESS DRIVE-ON BASE



ECO DRIVE-ON BASE



SET INCLUDES

- flag
- heavy-duty pole
- carry bag

MATERIALS

- Polyglans 115 g/m²
- Polyglans 115 g/m² B1
- Air Polyglans 115 g/m²



● SQUARE BEACHFLAGS

S - small | 300 cm

M - medium | 400 cm

L - large | 500 cm

Square version of heavy duty beachflags. Offered in three sizes with the possibility of adding a wide selection of bases. Used on various surfaces such as sand, snow, ice, concrete, or grass. The system is portable, quick and easy to assemble.

● BASES

BLACK SPIKE



BLACK CROSSBASE



BLACK WATERBAG



HEAVY FLAT METAL BASE

6 kg
15 kg
20 kg



HEAVY ECO BASE

5 kg
12 kg



PLASTIC FILLABLE BASE
(FOR WATER OR SAND)



BUSINESS DRIVE-ON BASE



ECO DRIVE-ON BASE



● SET INCLUDES

- flag
- heavy-duty pole
- spike base (black)
- carry bag

● MATERIALS

- Polyglans 115 g/m²
- Polyglans 115 g/m² B1
- Air Polyglans 115 g/m²



○ BACKFLAGS

ECO
BUSINESS

Backflags – small beachflags, worn on the back, will allow an effective advertisement of the brand, e.g. leaflets distribution, sponsored walks, sport events, exhibitions. Available in two versions, Eco and Business. Both versions are light-weight and portable.

● DETAILS

ECO BACKFLAG



BUSINESS BACKFLAG

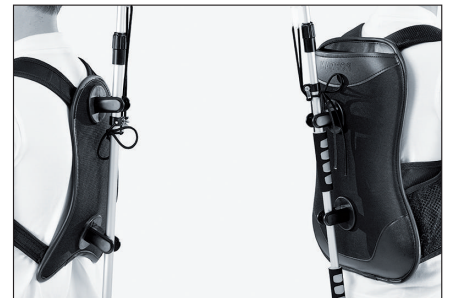

● SET INCLUDES

- flag
- telescopic aluminium pole
- backpack
- carry bag

● MATERIALS

- Polyglans 115 g/m²
- Polyglans 115 g/m² B1
- Air Polyglans 115 g/m²



○ TEXTILE BANNERS

Banners are a highly popular, cost effective advertising and communication tool. High resolution print guarantees the most complex visual projects will look outstanding on a wide range of textile materials. Banners are available in custom-made sizes and finishing.

● FINISHING EXAMPLES

METAL STICK



WOODEN STICK

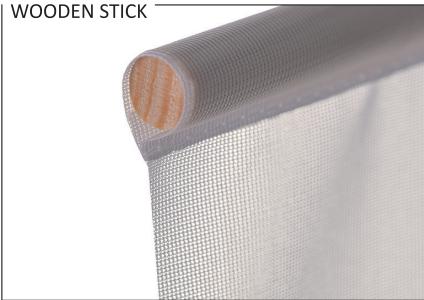

ALU SNAP PROFILE



EVO PROFILE

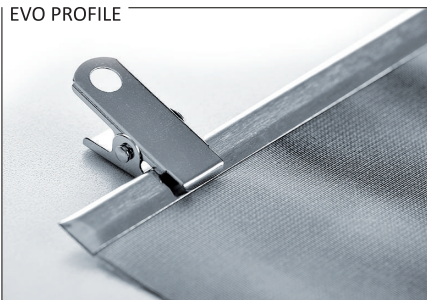

SILICONE TAPE



KEDER



● MATERIALS

- Decor 205 g/m² B1
- Polyglans 115 g/m²
- Polyglans 115 g/m² B1
- Air Polyglans 115 g/m²
- Satin 140 g/m² B1
- Decor Blockout 400 g/m²
- Decor Backlite 165 g/m² B1
- Decor Blockout black back 250 g/m² B1
- Stretch Backlite 210 g/m² B1
- Samba 195 g/m² B1



○ PVC BANNERS

Banners are a very popular advertising and communication tool. High resolution UV print guarantees that most complex visual projects will look outstanding on a wide range of our PVC materials. Banners are available in custom-made sizes and finishing.

● FINISHING EXAMPLES

METAL EYELET

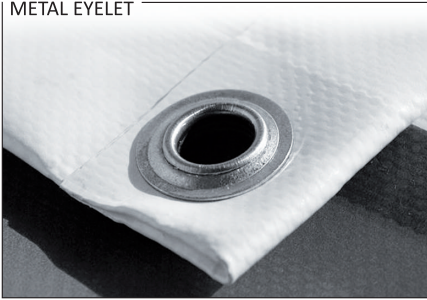

TUNNEL / SLEEVE



KEDER



ALU SNAP PROFILE



● MATERIALS

- Frontlit 500 g/m² B1
- Mesh 330 g/m² B1
- Double-sided mesh 330 g/m² B1
- Blockout 650 g/m² B1
- Polycanvas 270 g/m²
- PVC Backlite 150 g/m² B1



○ BUSINESS ALUMINIUM FRAME

max length of a profile 300 cm

Business version of aluminium frame which can be mounted to a wall or free-standing with stable feet. Aluminium profiles are 33 mm deep and allow graphics placement to the front and back. Graphics can be printed on various materials finished with silicone tape, which makes it cost-effective and easy to replace. Free-standing system is supported with H-profiles to make it more stable. Perfect for indoor use such as retail, exhibitions and events.

● DETAILS

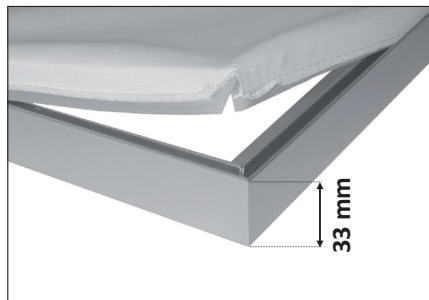
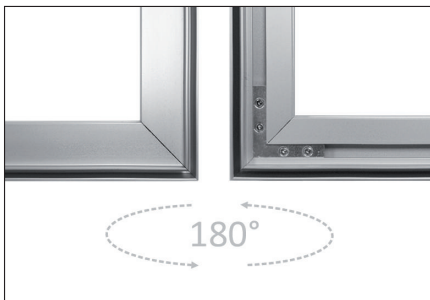

● SET INCLUDES

- graphics
- system

● MATERIALS

- Decor 205 g/m² B1
- Decor Backlite 165 g/m² B1
- PVC Backlite 150 g/m² B1
- Decor Blockout black back 250 g/m² B1
- Stretch Backlite 210 g/m² B1
- Samba 195 g/m² B1

○ FREE-STANDING
BUSINESS ALUMINIUM FRAME



● OPTIONAL: BASES

BOOMERANG BASE

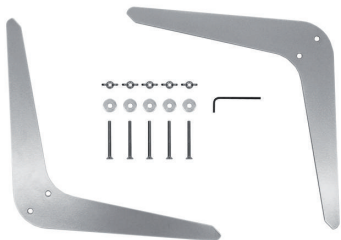

METAL BASE

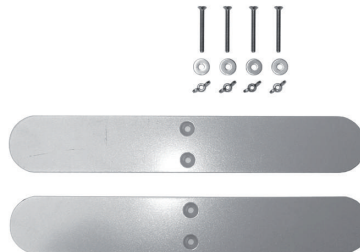

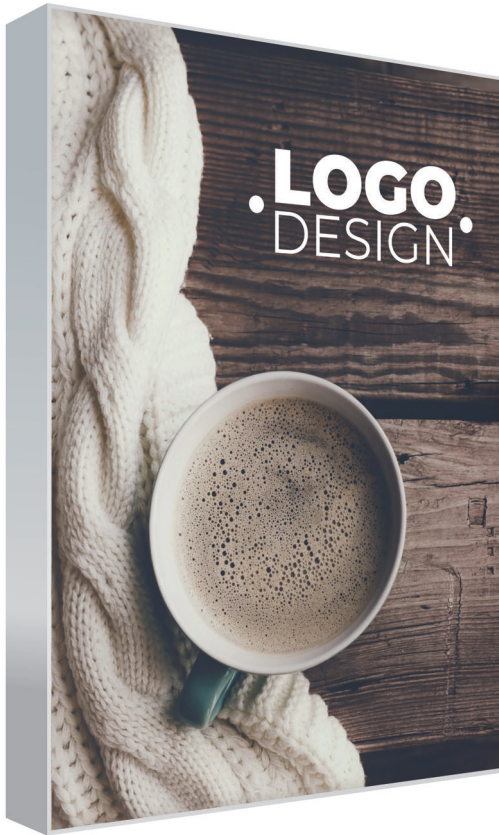

● ECO ALUMINIUM FRAME

max length of a profile 300 cm

Perfect solution to put an eye-catching graphics on the wall. Graphics can be printed on various materials finished with silicone tape, which makes it cost-effective and easy to replace. Aluminium profiles are single-sided and 25 mm deep. The profiles are 300 cm long and can be joined together to make larger size frames. Perfect for indoor use such as retail, exhibitions and events.

● DETAILS

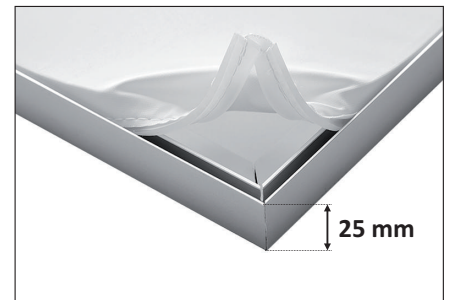

● SET INCLUDES

- graphics
- system

● MATERIALS

- Decor 205 g/m² B1
- Decor Backlite 165 g/m² B1
- PVC Backlite 150 g/m²
- Decor Blockout black back 250 g/m² B1
- Stretch Backlite 210 g/m² B1
- Samba 195 g/m² B1



● BLACK ECO ALUMINIUM FRAME

max length of a profile 300 cm

Perfect solution to put an eye-catching graphics on the wall. Graphics can be printed on various materials finished with silicone tape, which makes it cost-effective and easy to replace. Black aluminium profiles are single-sided and 25 mm deep. The profiles are 300 cm long and can be joined together to make larger size frames. Perfect for indoor use such as retail, exhibitions and events.

● DETAILS

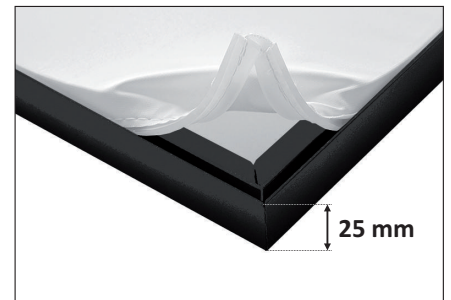

● SET INCLUDES

- graphics
- system

● MATERIALS

- Decor 205 g/m² B1
- Decor Backlite 165 g/m² B1
- PVC Backlite 150 g/m² B1
- Decor Blockout black back 250 g/m² B1
- Stretch Backlite 210 g/m² B1
- Samba 195 g/m² B1



WOODEN FRAME

A4
A3
A2
A1
50 x 50 cm
60 x 60 cm
60 x 80 cm
70 x 100 cm
80 x 100 cm
90 x 120 cm

Graphics for our wooden frames are printed on a high quality PVC Polycanvas 270 g/m². Printed image is fitted on a frame made of Polish pinewood, impregnated with wax and natural oils. Our wood comes from well-managed forests, certified according to the standards of NC-FM / COC-016493. Wooden frames are available in various sizes. Ideal for indoor advertising such as office interiors, hotels and shopping centers.

DETAILS

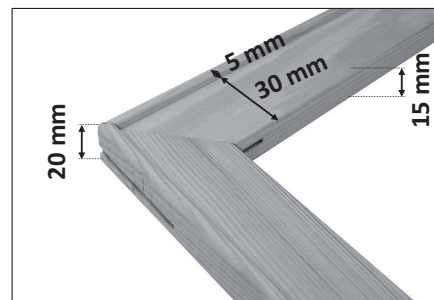

SET INCLUDES

- graphics
- wooden frame

MATERIAL

- Polycanvas 270 g/m²



EVENT FLAGPOLE 5m

110 x 400 cm

Easy to use portable flagpole system perfect for outdoor events, such as: exhibitions, street events, trade fairs. System includes telescopic pole, which allows the flagpole to be set up at different heights (min. 167 cm and max. 500 cm). Fillable base adds greater stability.

DETAILS



SET INCLUDES

- flag 110 x 400 cm
- telescopic pole
- plastic fillable base
- 2 carry bags

MATERIALS

- Polyglans 115 g/m²
- Polyglans 115 g/m² B1
- Air Polyglans 115 g/m²



○ ECO ROLL-UPS

- 85 x 200 cm
- 100 x 200 cm
- 120 x 200 cm

Roll-ups are high-impact, cost-effective display systems used to advertise products and services. They are portable, simple to use and perfect for a wide range of applications such as exhibitions, presentations, conferences, etc.

● DETAILS



● SET INCLUDES

- graphics
- system
- carry bag

OPTIONAL: Spotlight

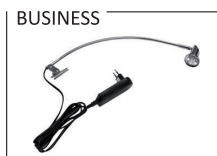
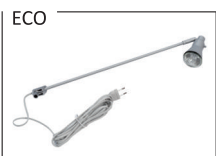

● MATERIALS

- Frontlit 500 g/m² B1
- Polycanvas 270 g/m²
- Decor 205 g/m² B1
- Blockout 440 g/m²



○ BUSINESS ROLL-UP

85 x 200 cm

Business version of popular Roll-ups. Perfect for a wide range of applications such as exhibitions, presentations, conferences, etc. Premium quality solid base with silver-plated sides gives an outstanding look and adds stability to the system. Telescopic pole height can be adjusted from 165 cm to 208 cm. Supplied with a black foam-padded carry bag.

● DETAILS

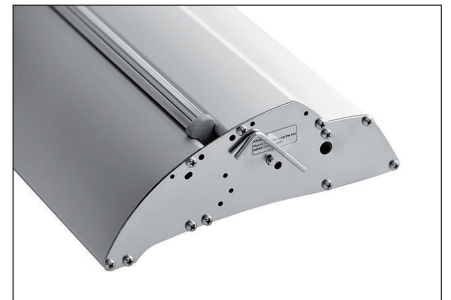

● SET INCLUDES

- graphics
- system
- foam-padded carry bag

OPTIONAL: Spotlight

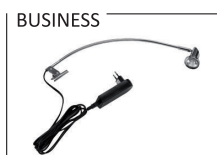
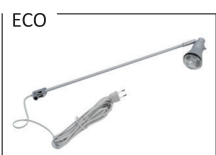

● MATERIALS

- Frontlit 500 g/m² B1
- Polycanvas 270 g/m²
- Decor 205 g/m² B1
- Blockout 440 g/m²



DOUBLE-SIDED ROLL-UP

85 x 200 cm

Double-sided version of Business Roll-up is a high-impact, cost-effective display system used to advertise products and services. It is portable and simple to use. Perfect for a wide range of applications such as exhibitions, presentations, conferences, etc. Premium quality solid base with silver-plated sides gives an outstanding look and makes the system more stable. Supplied with a black foam-padded carry bag.

DETAILS



SET INCLUDES

- graphics
- system
- carry bag

OPTIONAL: Spotlight

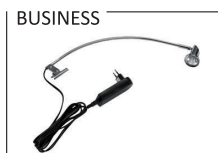
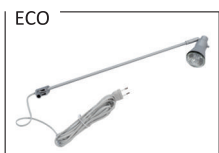

MATERIALS

- Frontlit 500 g/m² B1
- Polycanvas 270 g/m²
- Decor 205 g/m² B1
- Blockout 440 g/m²



○ MINI ROLL-UPS

A4 | 21 x 29,7 cm

A3 | 29,7 x 42 cm

Mini Roll-up is an eye-catching, cost effective small display system. Suitable for use in hotel receptions, restaurants, customer help desks. Mini Roll-ups work in the same way as the full size versions. With graphics rolling into the small silver cassette, mini roll-up is an ideal compact advertising tool.

● DETAILS

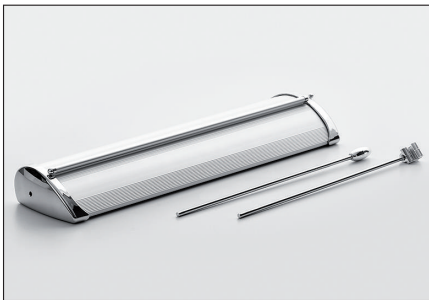

● SET INCLUDES

- graphics
- system

● MATERIAL

- Polycanvas 270 g/m²



○ L-BANNER

75 x 200 cm

90 x 200 cm

L-banners are high-impact, economical and light-weight display systems used in advertising of products and services. Featuring superb high definition graphics. They are portable and simple to use. Perfect for a wide range of applications, such as exhibitions, trade shows, malls, etc.

● DETAILS



● SET INCLUDES

- graphics
- system
- carry bag

● MATERIALS

- Frontlit 500 g/m² B1
- Polycanvas 270 g/m²
- Decor 205 g/m² B1

OPTIONAL: Spotlight

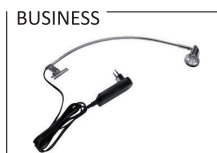
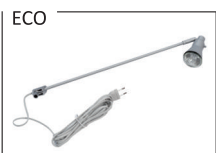



DOUBLE-SIDED L-BANNER

90 x 200 cm

Double-sided version of L-banner is a high-impact, cost-effective display system used to advertise products and services. It is portable and simple to use. Perfect for a wide range of applications such as exhibitions, presentations, conferences, etc.

DETAILS



SET INCLUDES

- graphics
- system
- carry bag

MATERIALS

- Frontlit 500 g/m² B1
- Polycanvas 270 g/m²
- Decor 205 g/m² B1

OPTIONAL: Spotlight

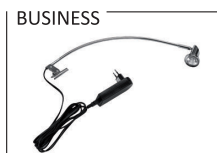
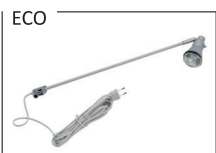



○ X-BANNER

80 x 180 cm

X-banners are ideal for a wide range of applications such as exhibitions, presentations, conferences, business meetings, trade fairs, etc. X-banners are flexible, light-weight and easy to carry. Graphics can be easily replaced. Supplied with a nylon bag. Every banner stand comes as a complete set with custom printed graphics.

● DETAILS

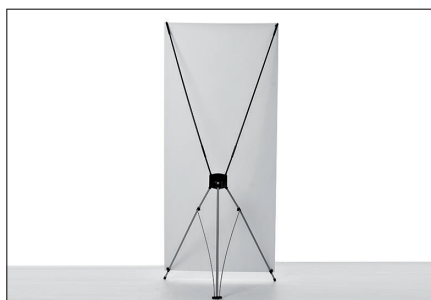

● SET INCLUDES

- graphics
- system
- carry bag

● MATERIALS

- Frontlit 500 g/m² B1
- Polycanvas 270 g/m²



○ SEG TABLE

with / without LED

100 x 100 x 38 cm

Quick and easy to assemble, this portable and lightweight fabric counter is suitable for indoor use such as exhibitions, conferences, presentations and more. Comes with custom printed fabric graphics with sewn in silicone tape. Available in two versions: illuminated or non-illuminated.

● DETAILS

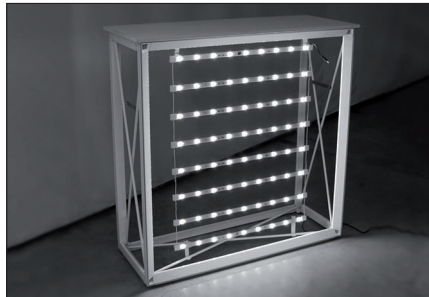
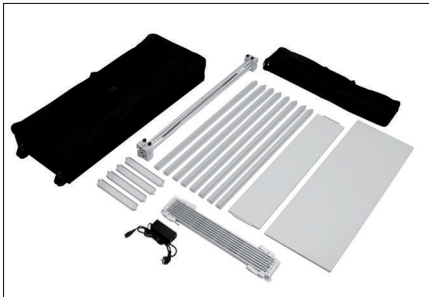

● SET INCLUDES

- system with white top
- shelf (1 pc)
- graphics
- soft padded wheeled bag
- LED curtain 70 W (version with LED)

● MATERIALS

SEG table with LED:

- Decor Backlite 165 g/m² B1
- PVC Backlite 150 g/m² B1
- Samba 195 g/m² B1

SEG table without LED:

- Decor 205 g/m² B1
- Decor Blockout black back 250 g/m² B1



○ EXPO TABLE

102 x 106 x 40 cm

Expo Table is used to advertise products and services. Easy to assemble, light-weight system with fabric print. Velcro finish makes the graphics quick and easy to replace. Perfect for a wide range of applications such as exhibitions, presentations, conferences, etc.

● DETAILS



● SET INCLUDES

- system
- 2 shelves
- top (black or wooden colour)
- graphics
- soft, wheeled case

● MATERIAL

- Decor 205 g/m² B1



○ QUICK TABLE

70 x 100 cm

Automatic Fabric Counters have been designed with portable and easy set-up in mind which makes it excellent for events and exhibitions.

Telescopic hardware allows for the counter to automatically assemble from a single touch in less than a few seconds and pack away in the same time, making it ideal for exhibitors who are always on the go.

Available in oval shape, the textile graphics can be easily washed if needed. The Quick table comes with a carry bag for easy transportation.

● DETAILS



● SET INCLUDES

- black top
- graphics
- bag

● MATERIAL

- Stretch 240 g/m² B1



COCTAIL TABLE

80 x 110 cm

Elegant and representative cocktail table intended for all events, banquets, and conferences.

Made of high-quality materials. The tabletop is made of very durable polyethylene and the frame is made of steel.

It has a convenient folding system that takes just a few seconds and can be easily stored and transported.

The product has an additional lock that protects against accidental unfolding. The table legs are protected with rubber pads that protect the surface from scratching and the table from sliding.

DETAILS

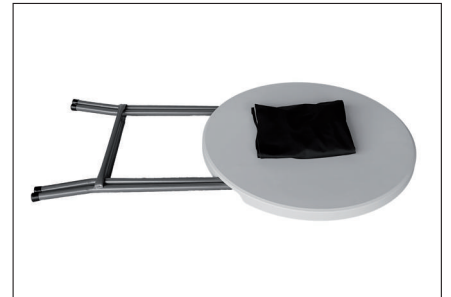
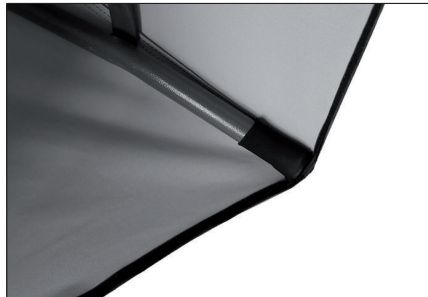

SET INCLUDES

- white top
- graphics

MATERIAL

- Stretch 240 g/m² B1



● SEG POP UP WITHOUT LED

Printed single or double-sided, this highly portable and easy to set up, seamless fabric display system is ideal for use as a back wall at events, exhibitions, retail stores and photo shoots. Uses graphics with silicone tape sewn to the edge of the fabric, which makes the print clear and flat, resulting in a photo quality standard. Optional set of spotlights is ideal for illuminating the display to make the artwork stand out. Supplied with a wheeled carry bag, allowing for easy transportation and storage. Frames can be joined together to fill larger areas.

OPTION 1: single-sided



OPTION 2: double-sided



● AVAILABLE SIZES

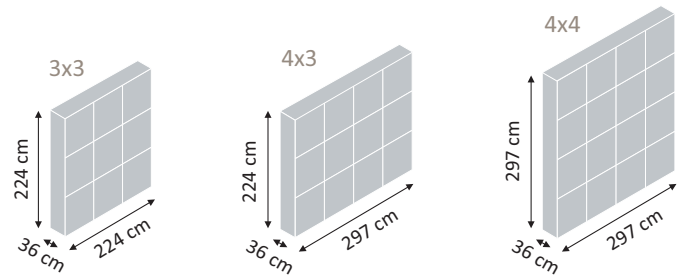

● DETAILS

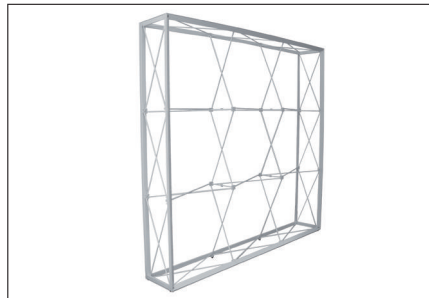

● SET INCLUDES

- system
- graphics option 1 or 2
- soft padded wheeled bag

● MATERIALS

- Decor 205 g/m² B1
- Decor blockout back back 250 g/m² B1

● OPTIONAL: LED Spotlight



● OPTIONAL: Base

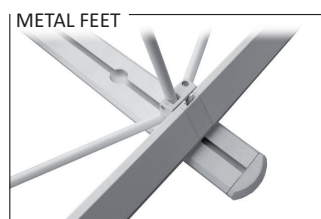



● SEG POP UP WITH LED

Printed single or double-sided, this highly portable and easy to set up, seamless fabric display system is ideal for use as a back wall at events, exhibitions, retail stores and photo shoots. Uses graphics with silicone tape sewn to the edge of the fabric, which makes the print clear and flat, resulting in a photo quality standard. The print is illuminated by using curtains of flexible LED lights that are suspended internally on the frame. Supplied with a wheeled carry bag, allowing for easy transportation and storage. Frames can be joined together to fill larger areas.

OPTION 1: single-sided



OPTION 2: double-sided



● AVAILABLE SIZES

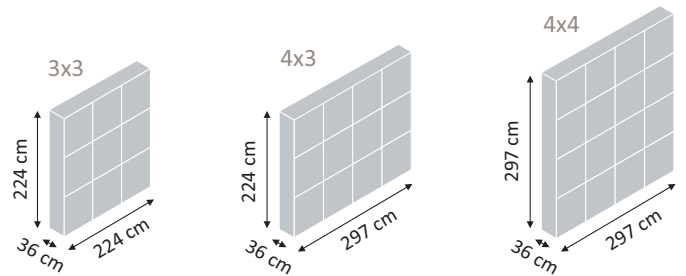

● DETAILS

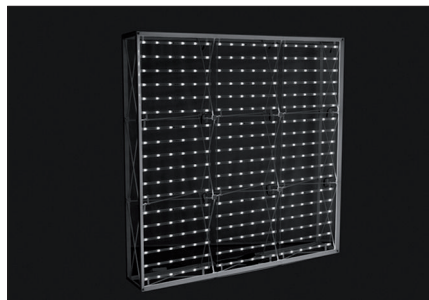

● SET INCLUDES

- system
- graphics option 1 or 2
- soft padded wheeled bag
- extension cord (length: 450cm)
- LED

LED set 3x3 - 9 LED curtains 30W
 LED set 4x3 - 12 LED curtains 30W
 LED set 4x4 - 16 LED curtains 30W

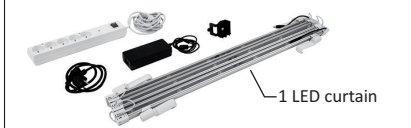

● MATERIALS

- Decor Backlite 165 g/m² B1
- PVC Backlite 150 g/m² B1
- Samba 195 g/m² B1

● OPTIONAL: Base

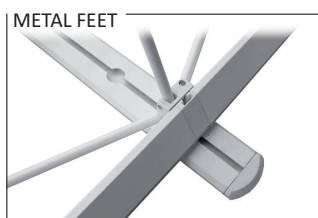



● POP-UP WALLS

230 x 230 cm
300 x 230 cm
300 x 300 cm

Eye-catching display systems used to present products and services in a large format. Easy to assemble, light-weight systems with fabric print. Velcro finish makes the graphics quick and easy to replace. Perfect for a wide range of applications such as exhibitions, presentations, conferences, etc.

● DETAILS



● SET INCLUDES

- graphics
- system
- 2 spotlights
- soft, wheeled case

● MATERIAL

- Decor 205 g/m² B1



● CURVED POP-UP WALL

350 x 225 cm

An eye-catching display system used to present products and services in a large format. Built on the pop-up structure with wrap around graphics, this portable system is extremely quick and easy to assemble. Perfect for a wide range of applications such as exhibitions, presentations, conferences, etc.

● DETAILS

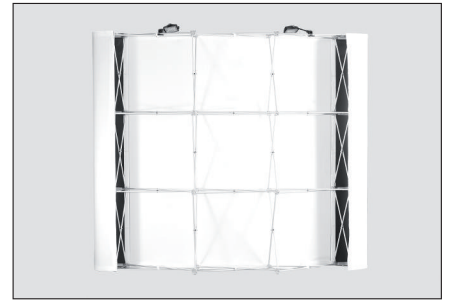

● SET INCLUDES

- graphics
- system
- 2 spotlights
- soft, wheeled case

● MATERIAL

- Decor 205 g/m² B1



○ FLEX WALL

Portable, light-weight system, perfect for events and exhibitions. The system contains telescopic poles, which can be adjusted to various sizes. Graphics can be printed on either Décor 205 g/m² B1 (max. size 240 x 305 cm), or double-sided Décor Blockout 400 g/m² (max. size 220 x 220 cm). System is supplied with stable metal feet and a protective bag.

● DETAILS



● SET INCLUDES

- system
- graphics
- carry bag

● MATERIALS

- Décor 205 g/m² B1
- Décor Blockout 400 g/m²



○ ZIPPER WALLS

ZIPPER WALL STRAIGHT 2.4m, 3m, 4m, 6m

ZIPPER WALL CURVED 2.4m, 3m

ZIPPER WALL WAVE 3m

Light-weight systems with double-sided fabric graphics used to present products and services. Easy to assemble and to replace the graphics. Perfect for a wide range of applications such as exhibitions, presentations, conferences, etc.

● AVAILABLE SHAPES & SIZES

ZIPPER WALL STRAIGHT

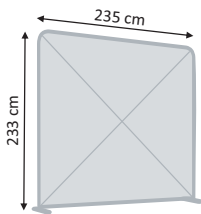

2,4 m

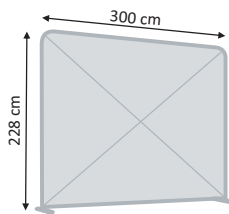

3 m

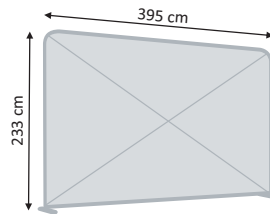

4 m

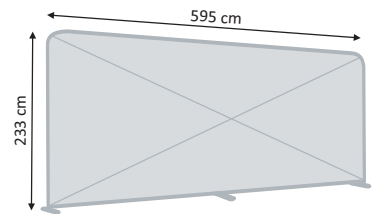

6 m

ZIPPER WALL CURVED

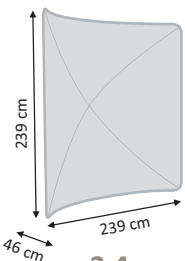

2,4 m

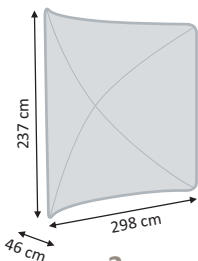

3 m

ZIPPER WALL WAVE

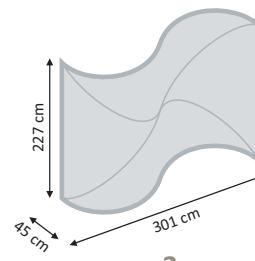

3 m

● SET INCLUDES

- system
- graphics
- feet (Zipper Wall Straight)
- soft bag

● MATERIAL

- Decor 205 g/m² B1
- Stretch 240 g/m² B1

● BEACHBANNERS

S - small | 138 x 70 cm

M - medium | 194 x 85 cm

L - large | 258 x 100 cm

Portable promotional display systems perfect for outdoor events. They can be used on various surfaces, such as sand, grass, snow etc. The beachbanner set includes two graphics printed on Décor 205 g/m² B1, 4 spikes and a carry bag.



● DETAILS



● SET INCLUDES

- graphics
- system
- 4 spikes
- carry bag

● MATERIAL

- Décor 205 g/m² B1



DOUBLE-SIDED ALUMINIUM A-FRAMES

100 x 100 cm

100 x 200 cm

These are new light-weight promotional display systems perfect for outdoor events. Set includes two graphics printed on either Décor 205 g/m² B1 or Frontlit 500 g/m² B1, 4 spikes and a carry bag. Available in two sizes.

DETAILS

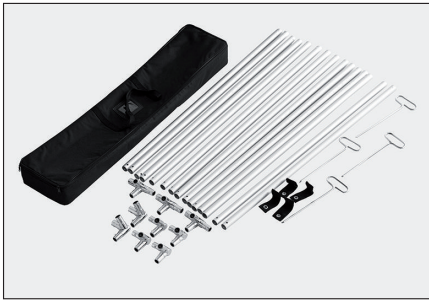

SET INCLUDES

- 2 graphics
- aluminium poles
- 4 spikes
- carry bag

MATERIALS

- Décor 205 g/m² B1
- Frontlit 500 g/m² B1



○ BANNER ARM

max 82 x 300 cm

High quality, stainless-steel system mounted directly onto a wall, or any other solid structure. High-impact, replaceable graphics, printed on different fabric and PVC materials is good for advertising location and promoting business. Max. recommended print height is 300 cm.

● DETAILS

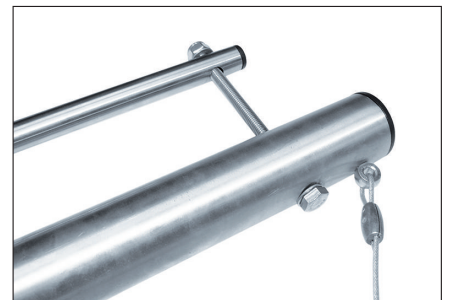
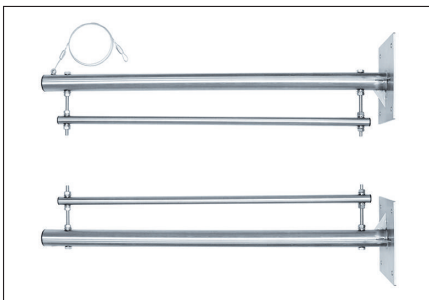

● SET INCLUDES

- stainless steel arms
- steel cord
- graphics

● MATERIALS

- Blockout 650 g/m² B1
- Decor 205 g/m² B1
- Polyglans 115 g/m²
- Frontlit 500 g/m² B1

○ OUTDOOR H-FIX SYSTEM

max 100 x 300 cm

A flexible solution used on soft grounds, such as grass, sand, or snow. The system is easy to assemble. Its light-weight design and competitive price makes it truly unique. Depending on a chosen material, the maximum banner size to fit this hardware is 100 cm in height and 300 cm in width.



● DETAILS



● SET INCLUDES

- 2 aluminium poles
- 2 screw bases
- 4 spikes and 2 ropes
- 4 rubber mountings
- carry bag

● MATERIALS

- Decor 205 g/m² B1
- Polyglans 115 g/m²
- Frontlit 500 g/m² B1
- Mesh 330 g/m² B1
- Blockout PVC 650 g/m² B1



○ SKYDANCERS

- 1 LEG - 6 m
- 2 LEGS - 8 m

Inflatable dancer, powered by an air blower. 1-leg version is 6 m high and supplied with 1 blower. 2-leg version is 8 m high and supplied with 2 blowers.

● DETAILS

SKYDANCER 1 LEG - SET



SKYDANCER 2 LEGS - SET



● SET INCLUDES

- graphics
- blower 230 V, 950 W
- AC cable length 160 cm

● MATERIAL

- Polyester 75 g/m²



EXPO TENT

300 x 300 cm

Expo Tent comes with a stable aluminium-frame system, custom printed top, spikes, rope and a protective bag. The inner tent size is 3 x 3 m with an adjustable height up to 240 cm. As an option it is also possible to add custom printed walls. Top and walls are printed on high quality water-repellent Polytent 220 g/m² (textile) or waterproof Polytent PVC 330 g/m² with B1 certificate. Perfect for a wide range of applications such as exhibitions, presentations, conferences, etc.

OPTIONAL



DETAILS

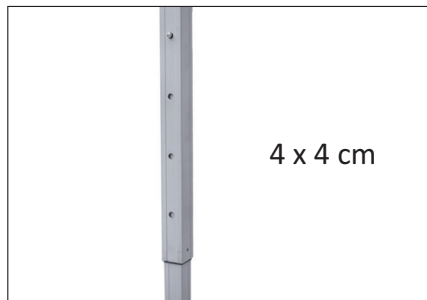

SET INCLUDES

- custom printed top
- aluminium poles 4 x 4 cm
- spikes and ropes
- soft wheeled bag
- printed walls (optional)

MATERIALS

- Polytent SUN 285 g/m² B1 (textile)
- Polytent PVC 330 g/m² B1



○ CEILING SYSTEMS

TRIANGLE h 107 cm, side 306 x 107 cm

CIRCLE h 107 cm, ø 305 cm

SQUARE h 107 cm, side 217 x 107 cm

Large format advertising systems perfect for indoor events and exhibitions. Available in 3 shapes: circle, triangle and square. Easy to assemble high quality aluminium poles. The system comes with a padded bag.

● DETAILS



CIRCLE - SET

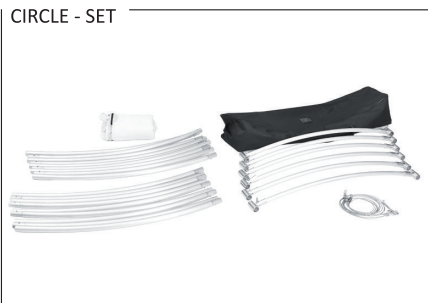

TRIANGULAR - SET

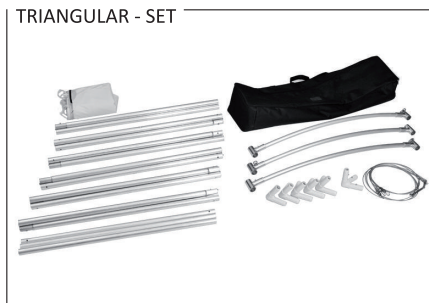

SQUARE - SET

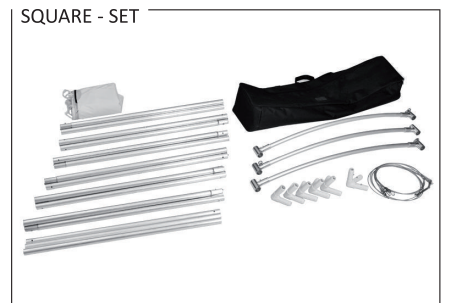

● SET INCLUDES

- graphics
- system
- hanging set
- steel cords
- padded bag

● MATERIAL

- Decor 205 g/m² B1



○ BACKDROPS

Backdrops are used as an eye-catching interior/exterior decoration at music events, concerts, festivals, theatres, etc. Backdrops can be produced in various sizes. They come with different graphics, and a wide range of finishing.

● FINISHING

METAL EYELET



TUNNEL

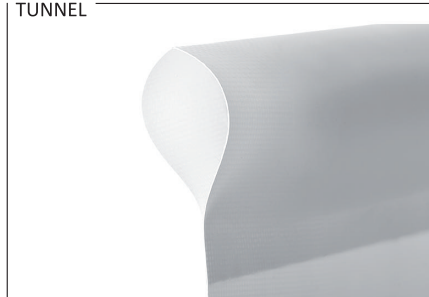

KEDER

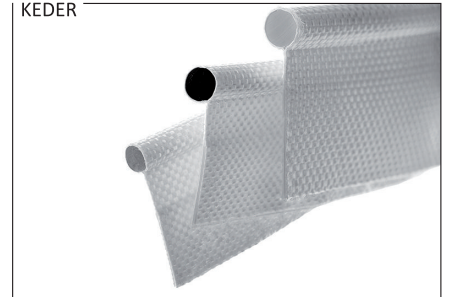

● MATERIALS

- Decor 205 g/m² B1
- Polyglans 115 g/m²
- Polyglans 115 g/m² B1
- Air Polyglans 115 g/m²
- Frontlit 500 g/m² B1
- Mesh 330 g/m² B1



○ FLATBED

PVC Foam white 3 mm / 5 mm / 10 mm
 Channel Plate white 3 mm / 5 mm / 10 mm
 Alu Bond 3 mm

Flatbed printing offers a wide range of display possibilities. Printing on rigid media allows to produce any kind of indoor and outdoor signage. Printed boards may be cut to any chosen size and shape. In our offer you will find PVC Foam, Alu Bond and Channel plate.

● RIGID MEDIA

PVC FOAM



CHANNEL PLATE

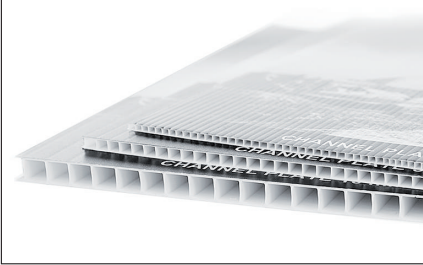

ALU BOND

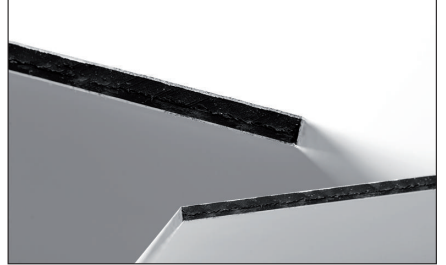

● ACCESSORIES

DESK BASE



WALL DISTANCES / STANDOFFS 25mm



WALL DISTANCES / STANDOFFS 50mm





● VELOUR 1800 g/m² FLOORING FOAM 1000 g/m²

Max width of both materials: 200 cm

Flooring foam and Velour materials allow decoration of floors during events, trade shows and galas. We offer quality flooring materials with high resolution UV print.

● DETAILS

VELOUR

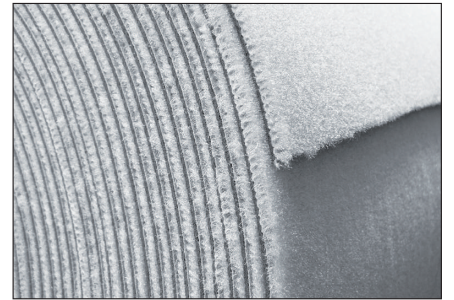
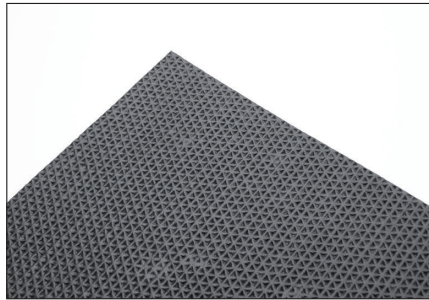
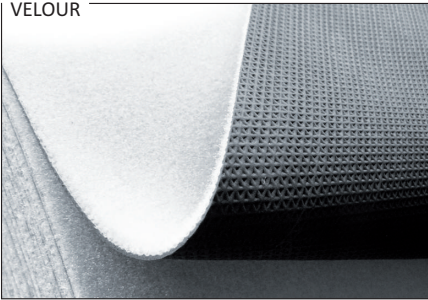

FLOORING FOAM

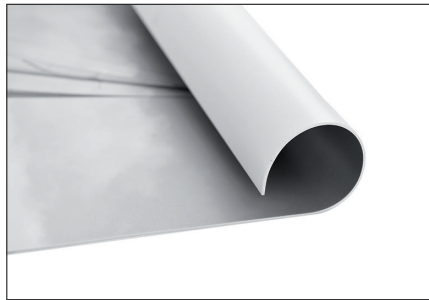
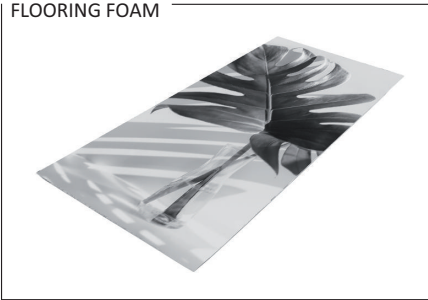



○ PALLET COVERS

Perfect way to protect the pallets from dirt and dust as well as advertise products and brands. They are printed on both PVC and fabric materials and can be made to custom specified sizes and heights.

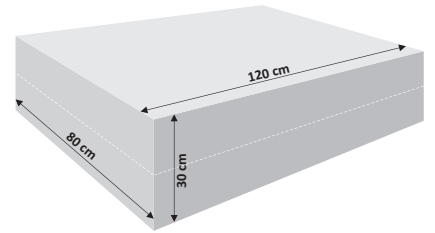
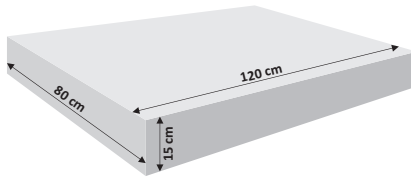
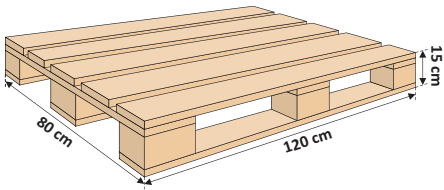

● DETAILS



● MATERIALS

- Decor 205 g/m² B1
- Frontlit 500 g/m² B1

OTHER PRODUCTS

We offer a wide range of other products, such as table cloths, curtains, alarm covers, barrier jackets, pennants, flaglines and pouf covers. These are all tailored to specific needs of our clients. Neat finish and highest quality materials (also available in a flame retardant range) allow our clients to use the products in public places and during large events and exhibitions. This page is to demonstrate our abilities to clients and encourage them to make inquiries, should they have any special requirements or extraordinary projects.

EXAMPLES

TABLE CLOTHS



SEAT COVERS



CURTAINS



POUF COVERS



ALARM COVERS

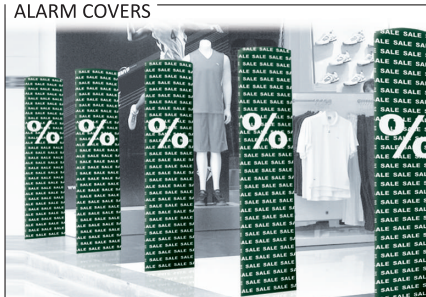

PENNANTS

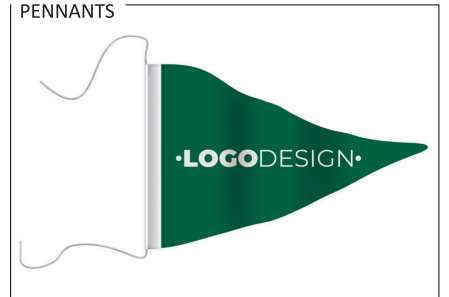

BARRIER JACKETS



FLAGLINES



CAR COVERS



○ TEXTILE MATERIALS: digital printing

● POLYGLANS 115 g/m²

Used in production of high-quality promotional goods. Its main feature is 100% legibility on reverse (mirror image effect). Also available in fire retardant form (B1 class certified material).

Application: flags, beachflags, indoor and outdoor banners

● AIR POLYGLANS 115 g/m²

Used in production of flags, including beachflags, where durability and resistance to harsh weather conditions is of high relevance. It characterizes with 100% legibility on reverse (mirror image effect). Also available in fire retardant form (B1 class certified material).

Application: flags, beachflags, indoor and outdoor banners

● SATIN 140 g/m² B1

Intended for single-sided prints. Used in production of high quality promotional indoor media (boutiques, showrooms, expositions, shop windows). The material is B1 fire rated.

Application: indoor advertising, banners

● DECOR 205 g/m² B1

Intended for single-sided prints. Used for producing high quality promotional media, displayed both indoors (boutiques, shops, showrooms, expositions, shop windows) and outdoors. The material is B1 fire rated.

Application: aluminium frames, display systems, indoor and outdoor banners, double sided flags

● DECOR BLOCKOUT 400 g/m²

Used for double-sided prints. Applied in production of high quality promotional media. Intended for indoor use only (boutiques, showrooms, exhibitions, shop windows).

Application: indoor banners

● DECOR BACKLITE 165 g/m² B1

High quality fabric for lightboxes and LED frames, printed with dye-sub. The material is B1 fire rated.

Application: illuminated frames

● DECOR BLOCKOUT 250 g/m² B1 BLACK BACK

A high quality one-side-print fabric. Its most important feature is black back layer, which completely prevents the light from coming through the print. The material is mainly used in indoor aluminium frames and in-store banners. The material is B1 fire rated.

Application: aluminium indoor frames, in-store banners

● SAMBA 195 g/m² B1

PVC Free polyester material fabric for both indoor and outdoor use. Crease free

Application: aluminium frames with lighting

● STRETCH BACKLITE 210 g/m² B1

High quality elastic fabric with anti-crease properties for lightboxes and LED frames, printed dye-sub. The material is B1 fire rated.

Application: aluminium frames with lighting

● STRETCH 240 g/m² B1

Top seller high quality elastic material for stretch banners.

○ PVC MATERIALS

● FRONTLIT COATED 500 g/m² B1

High quality PVC material with a matt surface. The material is B1 fire rated.

Application: façade advertisement, small and large-format advertisements, indoor and outdoor banners, display systems

● MESH 330 g/m² B1

High quality PVC material, with net structure. The material is B1 fire rated.

Application: small and large-format prints, outdoor banners

● DOUBLE-SIDED MESH 330 g/m² B1

Highest quality, B1 fire rated PVC material, with a net structure. Printed to both sides.

Application: small and large-format prints, outdoor banners

● POLYCANVAS 270 g/m²

PVC material with a structure resembling painted canvas.

Application: display systems, wooden frame

● BLOCKOUT 650 g/m² B1

Designed for double-sided prints. Used in production of high quality promotional media, intended for indoor (boutiques, showrooms, exhibitions, shop windows) and outdoor use (café barriers, lamppost banners). The material is B1 fire rated.

Application: indoor & outdoor banners

● PVC BACKLITE 150 g/m² B1

High quality PVC fabric for lightboxes for both indoor and outdoor use.

Application: illuminated frames

● VELOUR 1800 g/m²

Highest quality carpet-like material

Application: floor advertising, exhibitions

● FLOORING FOAM 1000 g/m²

Highest quality PVC material, with matt surface.

Application: floor advertising, exhibitions

○ FLATBED MATERIALS

● PVC FOAM WHITE

3 mm / 5 mm / 10 mm

Plates made out of foamed PVC, designed for various applications in advertising industry. They are light-weight and UV resistant. Print on both sides is possible on either 3 mm or 5 mm thick plates.

Size of plate: 203 x 305 cm

Application: signs, stands, display systems

● CHANNEL PLATE WHITE

3 mm / 5 mm / 10 mm

Due to their structure, channel plates are similar to cardboard, but more stiff and durable. They are light-weight and resistant to UV exposure. Print is possible on one side only.

Size of plates: 200 x 300 cm

Application: signs, boards, display systems

● ALU BOND WHITE

MATT / GLOSS 3 mm

The main advantages of aluminium plates are stiffness, smooth surface and high UV resistance. Plates have matt surface on one side and glossy surface on the other. By default, the prints are made on the matt side. Print on both sides is possible on request.

Max. size of plates: 150 x 405 cm

Application: signs, stands, display systems

○ ECO MATERIALS

● ECO AIR POLYGLANS 115 g/m² B1

Used in production of flags, including beachflags, where durability and resistance to harsh weather conditions is a top priority.

This provides 100 % legibility of the printed design on both sides of the textile (mirror effect)

Application: flags, beachflags, indoor and outdoor banners

● ECO POLYGLANS 115 g/m² B1

Used for the production of high-quality promotional articles. It characterizes with almost 100 % legibility of a printed design on both sides of the fabric (mirror effect). The yarn is made of recycled PET bottles

Application: flags, beachflags, indoor and outdoor banners

● ECO DECOR 215 g/m² B1

Intended for single-sided prints. Used for producing high quality promotional media displayed both indoors (boutiques, shops, showrooms, expositions, shop windows) and outdoors. The yarn is made of recycled PET bottles.

Application: aluminum frames, display systems, indoor and outdoor banners, double sided flags

● TEXTILE MESH 220 g/m² B1

PVC free, polyester equivalent of regular mesh material, printed with ecological method.

Application: facade advertisement, outdoor banners, small and large-format prints

● POLYMESH 180 g/m² B1

PVC free alternative is a regular mesh material. It's structure resembles pvc mesh, but it is made of polyester and resin

Application: facade advertisement, outdoor banners, small and large-format prints

● KAVALAN 360 g/m² B1

PVC free, polyester equivalent of regular frontlit material, printed with ecological method. 100% Polyester yarn, grey back.

Application: facade advertisement, outdoor banners, small and large-format prints

MATERIALS:

DIGITAL PRINT ON TEXTILE

- Polyglans 115 g/m²
- Polyglans 115 g/m² B1
- Air Polyglans 115 g/m²
- Air Polyglans 115 g/m² B1
- Satin 140 g/m² B1
- Decor 205 g/m² B1
- Decor Blockout 400 g/m²
- Decor Backlite 165 g/m² B1
- Decor Blockout black back 250 g/m² B1
- Samba 195 g/m² B1
- Stretch Backlite 210 g/m² B1
- Stretch 240 g/m² B1

DIGITAL PRINT ON PVC

- Frontlit coated 500 g/m² B1
- Mesh 330 g/m² B1
- Polycanvas 270 g/m²
- Blockout 650 g/m² B1
- Double-sided Mesh 330 g/m² B1
- PVC Backlite 150 g/m² B1
- Velour 1800 g/m²
- Flooring foam 1000 g/m²

ECO MATERIALS

- Eco Air Polyglans 115 g/m² B1
- Eco Polyglans 115 g/m² B1
- Eco Decor 205 g/m² B1
- Textile Mesh 220 g/m² B1
- Polymesh 180 g/m² B1
- Kavalan 360g/m² B1

FLATBED PRINTING

- Channel plate white 3 mm / 5 mm / 10 mm
- PVC foam white 3 mm / 5 mm / 10 mm
- Alu Bond white matt / white gloss 3 mm